

An Overview of WLAN: System Requirements and Practical Devices for Mobile WiFi

Apostolos Samelis and Darcy Poulin

Skyworks Solutions, Inc.

Riverside House, Riverside, Bishop's Stortford, CM23 3AJ, United Kingdom

OFDM Basics

WLAN systems today operate in the unlicensed 2.4 and 5 GHz bands and have benefited from the rapid evolution of the 802.11 standard – from 802.11b in 1999 offering CCK modulation with 20 MHz channel bandwidth (BW) at 2.4 GHz, to 802.11ac in 2012 featuring OFDM, MIMO, 80 MHz BW, 256 QAM, both at 2.4 and 5 GHz.

As loss between radios increases from an estimated 40 dB for 1m separation and increases with distance at a rate of about 0.5dB/m, the power amplifier (PA) in the transmitter and the low noise amplifier (LNA) in the receiver play a critical role in extending the range of the communication link (Fig. 1). For every 1 dB increment in transmitted power or reduction of noise figure, the linear range is increased by 8% (16% area); 3 dB increases range by 25% (56% area increase).

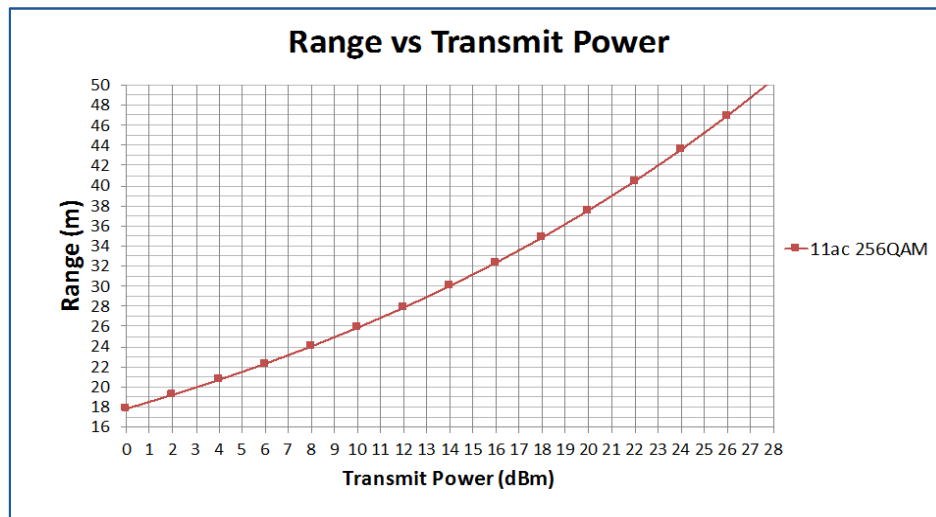

Fig. 1: Range vs. Transmit Power

Transmission at high data rates can be achieved by various methods:

- Decrease time period of each symbol. WLAN uses a symbol period of $T=4\mu\text{s}$ which corresponds to 250kbits/second.

- Increase the number of data carriers (OFDM). For example, 802.11 a/g uses 48 parallel subcarriers separated from each other by 312.5kHz and each modulated with a 1 or -1 pattern (BPSK). These increase data rate by 48x from 250kbps to ~12 Mbps. Each subcarrier is modulated with a +/- sine wave (BPSK). Each subcarrier maintains its state for a total of 4μs, and then the state changes. A 'symbol' is the aggregate sum of all 48 subcarriers. The "symbol length" is 4μs, and there is a new symbol every 4μs.
- Transmit more information on each subcarrier rather than only a 1 or a -1. For example, 4-PSK (QPSK) doubles the data rate from 12 Mbps to 24 Mbps.
- Change both the amplitude and the phase of the sine wave. For example, 16QAM assigns 4 bits per subcarrier ($2^4=16$) quadrupling the rate, from 12 Mbps to 48 Mbps. 64QAM uses 6 bits per subcarrier ($2^6=64$) resulting in 72 Mbps data rate (or 54 Mbps if one-quarter of the bits are repeated for redundancy - this is known as 64QAM-3/4). 256QAM uses 8 bits per subcarrier ($2^8=256$) and results in a data rate of 96Mbps. 1024QAM uses 10 bits per subcarrier ($2^{10}=1024$) producing a data rate of 120 Mbps (Fig.2).

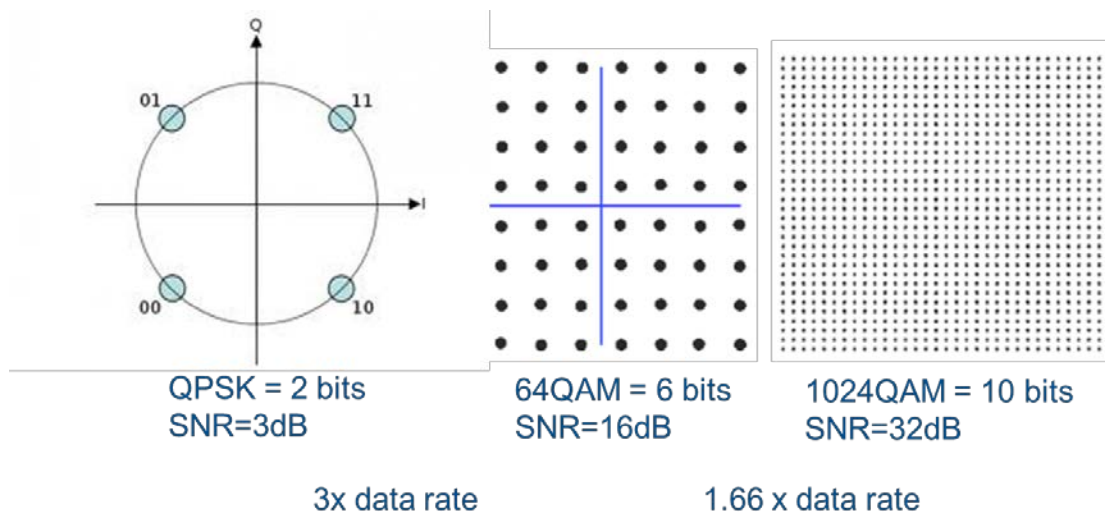

Fig. 2: Modulation vs. Data Rate Improvement

- Wider channel BW increases data capacity linearly: The BW can thus be increased by increasing the number of subcarriers while keeping the subcarrier spacing constant. For example, 802.11g uses 20MHz channels with 48 data subcarriers; 40MHz 11ac uses 108 subcarriers; 80MHz channels use 234 subcarriers; 160MHz channels use 468 subcarriers.
- Use MIMO to increase data rate. 802.11n introduced in 2007 uses 2x2 MIMO which explores multipath effects. Two independent streams are transmitted at the same time and on the same frequency, thus doubling overall throughput. Here, a rich multipath environment is required. As Fig. 3 shows, if we know the channel coefficients, we can recover TX1 and TX2 from RX1 and RX2.

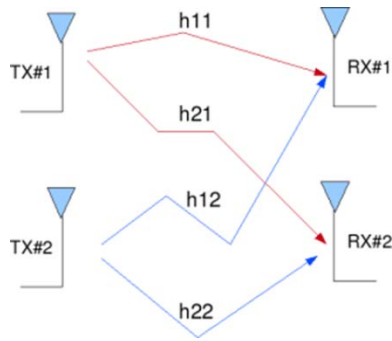

Fig. 3: Single-user or multi-user MIMO channel environment. We use training tones to measure h-parameters.

The Impact on Linearity

Using multiple subcarriers results in constructive and destructive signal combining in the time domain. This leads to large peak-to-average power ratios (PAPR), forcing the power amplifier to operate several dB below their maximum efficiency power level.

Fig. 4 shows the combined signal of 48 subcarriers, with their amplitudes randomly modulated between 0 and 1, and random phases between 0 and 360 degrees.

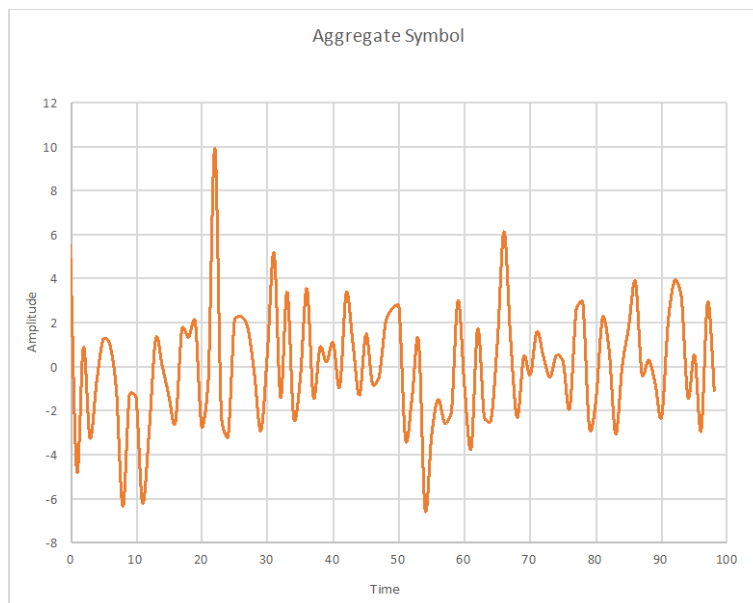

Fig. 4: Combined signal of 48 randomly modulated subcarriers

As one observes, PAPR has the characteristics of a statistical random process. It depends on the data being transmitted, since data sets the magnitude and phase of each subcarrier. PAPR depends only on the number of subcarriers ($10 \cdot \log N$). Practically, PAPR is independent from the number of subcarriers above 48, so PAPR is approximately constant versus channel bandwidth. In addition, PAPR does not depend on modulation type on each subcarrier. The magnitude and the phase of each subcarrier are much less important than the number of subcarriers. Subsequently, EVM is approximately independent of modulation type.

Impact on Practical Devices

Higher order modulations impose increased receiver sensitivity requirements (e.g. QPSK requires 3 dB SNR, 256QAM requires 26 dB SNR) and improved linearity on all components as they need to operate further away from their non-linear range (i.e. at backoff from P1dB). This results in reduced range, increased complexity and higher power consumption.

Wider bandwidths (from 20 MHz to 160MHz) also complicate PA/radio design, requiring additional spectrum and resulting in increased complexity and cost. Multiple devices imply linear increase in power consumption (2x2MIMO =2x power, 8x8 MIMO = 8x power), decreased battery life, and increased solution size.

Linearity Impairment by Transient Effects and Gain Equalization

The information needed for signal detection, frequency synchronization and channel estimation is retrieved from the short and long training symbols transmitted during the preamble of the 802.11 frame (Fig. 5).

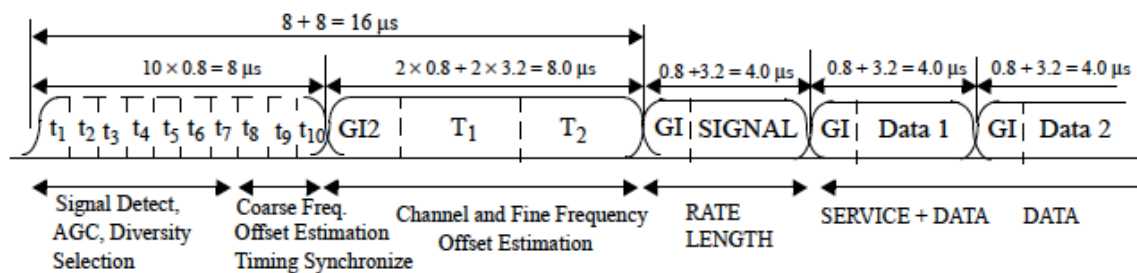

Fig. 5: 802.11a Frame

The FFT expression for symbol $r_{l,k}$ of the payload after long symbol detection and timing recovery:

$$r_{l,k} = K_{\text{mod}} \times a_{l,k} \times g_l \times H_k \times e^{j(\text{phase}_l^{(\text{common})} + \text{phase}_{l,k}^{(\text{timing})})} + n_{l,k}$$

where g_l : the gain at the symbol l in relation to the reference gain $g = 1$ at the long symbol (LS).

As the PA is turned on a few μs before the burst and its thermal turn-on transient does not settle until several hundreds of μs later, it will not reach steady state upon the arrival of the OFDM burst. Thus, g_l will vary during the thermal turn-on transient causing erroneous detection at the receiver.

Fig. 6 shows how a gain/output power transient is correlated to the dynamic error vector magnitude (DEVV). The graphs show various PA transient responses with respect to a “DEVV correction setting” control parameter [1].

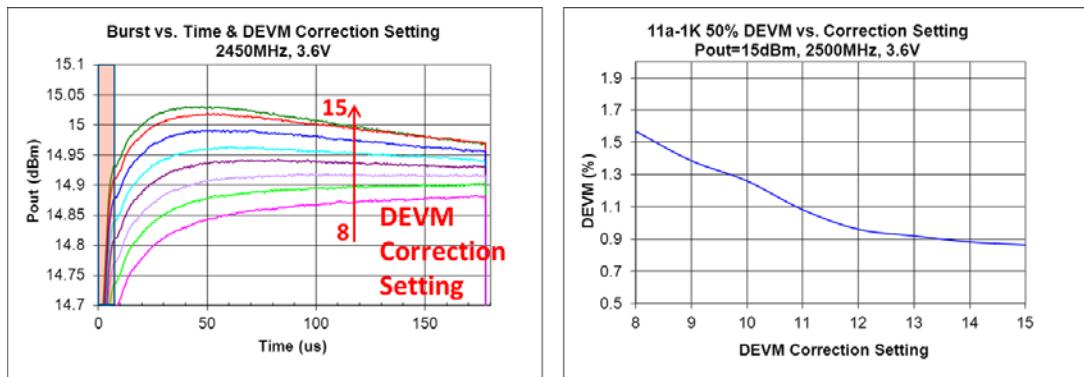

Fig. 6: Transient responses for a 1kB Data Burst (50% Duty Cycle) and effect on DEVM [1]

As one observes, PA turn-on transients settle after 100s of μs , i.e. during data transmission. To avoid impairment of the DEVM, either the gain variations must be tracked and corrected at the receiver, or the PA gain turn-on transient must be controlled so that it reaches steady state to within a few tenths of a dB from the gain set in the OFDM preamble.

As amplitude tracking is not part of the IEEE 802.11a standard requirements, it is necessary to implement some form of gain equalisation at the IC level, especially in higher power PAs, where self-heating effects are more pronounced. This effect is more important (and causes a lot more problems) in 802.11ac, since burst lengths are much longer: we now see burst lengths to 5ms, and the EVM has increased from -30dB (11n) to -40dB (11ac).

Power Amplifier with Gain Equalization

The PA presented in this work, was manufactured in a commercial $0.35\mu\text{m}$ SiGe BiCMOS technology. It is part of a 2GHz WLAN front-end module (FEM), together with a $0.25\mu\text{m}$ CMOS switch as shown in Fig. 7.

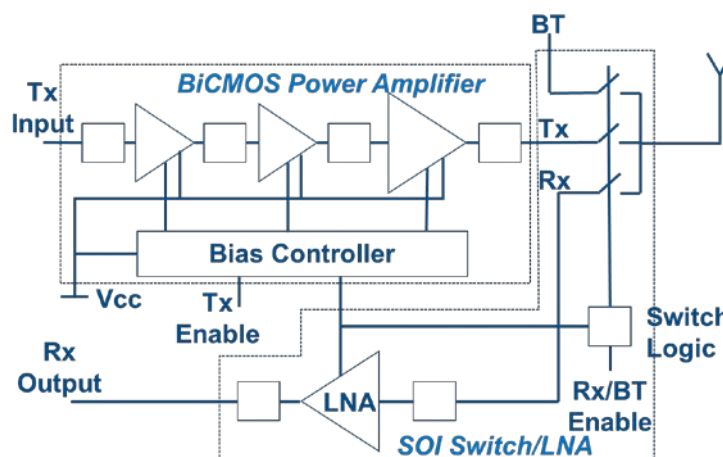

Fig. 7: 2GHz WLAN Front-end Module [2]

The PA consists of 3 stages, is fully internally matched, implements low drop-out regulator and is assembled in flip-chip configuration using copper pillar bumping. A PA die photograph is shown in Fig. 8 [2].

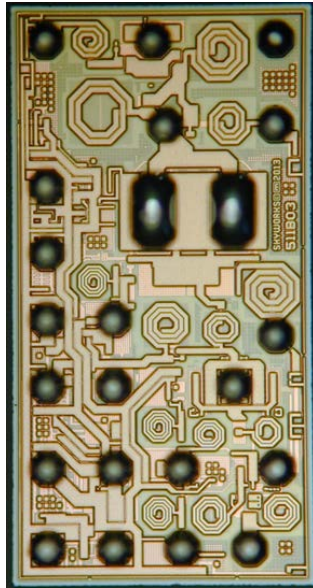

Fig. 8: 2GHz WLAN PA Schematic [2]

Gain equalization is achieved by specially designed circuits that generate current pulses into the reference bias currents of the amplifier. The pulses are based on fast capacitor charging at burst start and discharging during symbol transmission and their amplitude and rate of decay can be adjusted so that gain equalization and subsequently DEVM correction is dynamically tracking OFDM burst length and inter-frame spacing. Moreover, the pulses track voltage and temperature variations.

A model of the RF chain was developed using a mix of EM and compact models for active and passive elements, and interconnects. In the transmit mode (Tx) of operation, Fig.9 shows the measured and simulated small-signal gain of the FEM in the Tx mode at 3.3 V, 25 °C and the measured and simulated static EVM at 2.45 GHz under 802.11g 54 Mb/s modulation, as a function of output power. As one observes, the FEM achieves a -30.4 dB EVM at 20.3 dBm. Under 802.11ac modulation, it delivers 20.6 dBm for the same operating conditions.

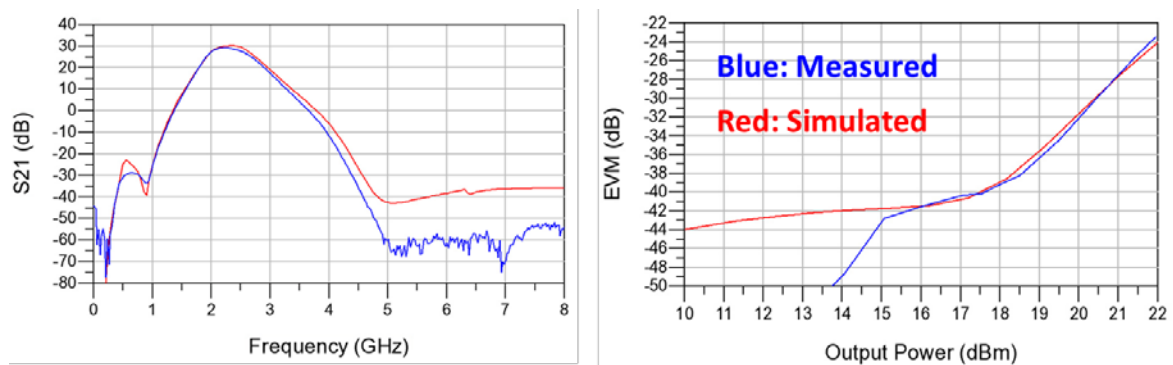

Fig. 9: Small and large-signal performance of the 2G WLAN FEM at 3.3V, 25°C [2]

Discrepancies between measured and modeled data can be attributed to the lack of a complete electro-thermal model that reflects the actual temperature profile across the die, process variations and assembly tolerances that could not be represented accurately in the FEM model.

The performance of the PA under long 802.11ac bursts and varying IFS and duty cycle is shown in Fig. 10.

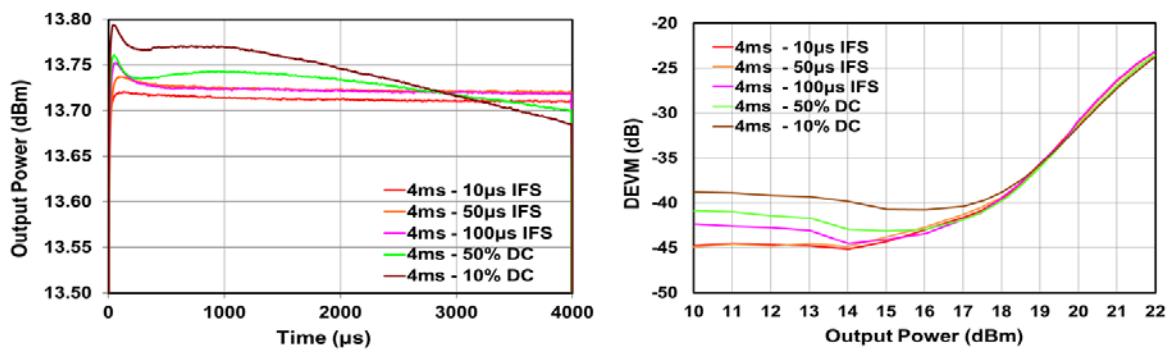

Fig. 10: Performance of the FEM under long 802.11ac bursts [2]

As one observes, the PA power remains within 0.1 dB from its steady state for the duration of burst even for the lowest duty cycle (10%). Consequently, the DEVM shows very little degradation as a function of output power for the various long word burst schemes. Comparing the graphs, one observes the relation between the DEVM at backed-off power levels and the power transient characteristic: a transient settling faster to the steady state results in low DEVM levels at backed-off power levels.

Conclusions

In this paper, we presented an overview of OFDM fundamentals and implications of high data rates on PAPR and PA linearity. The role of gain transients on linearity was discussed, and methods to compensate the DEVM impairments on practical devices due to gain transients were presented.

A WLAN flip-chip PA operating in the 2 GHz band has been presented. The PA delivers 29.5 dB small-signal gain and -30.4 dB EVM at 20.6 dBm at 3.3 V, 25 °C and demonstrates robust DEVM control under variable supply voltage, temperature, duty cycle, and burst length.

Acknowledgements

The authors acknowledge the contributions to this work by E. Whittaker, M. Ball, A. Bruce, J. Nisbet, L. Lam, C. Christmas, W. Vaillancourt, all from Skyworks Solutions, Inc.

References

- [1] A. Samelis, A., E. Whittaker, M. Ball, A. Bruce, J. Nisbet, L. Lam and W. Vaillancourt, "Front-end modules with versatile dynamic EVM correction for 802.11 applications in the 2GHz band", 2014 IEEE Topical Conference on Power Amplifiers for Wireless and Radio Applications (PAWR), pp. 10-12, January 2014.
- [2] A. Samelis, E. Whittaker, M. Ball, A. Bruce, J. Nisbet, L. Lam, C. Christmas, W. Vaillancourt, "A fully integrated flip-chip SiGe BiCMOS power amplifier for 802.11ac applications", 2016 IEEE Radio Frequency Integrated Circuits Symposium (RFIC), 2016, Pages: 314 - 317